

DIFFUSORI QUADRATI A 4 VIE

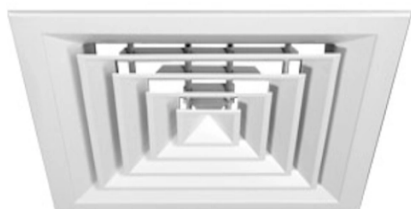

DESCRIZIONE

Diffusori quadrati a 4 vie con coni estraibili.

CARATTERISTICHE

Materiale: alluminio

Finitura: verniciato bianco

Installazione: fissaggio con viti non apparenti

ESECUZIONI SPECIALI

EDI4V-A: versione in alluminio anodizzato

ACCESSORI

Plenum zincato o isolato EPDM.

DIFFUSORE QUADRATO A 4 VIE

DISEGNI

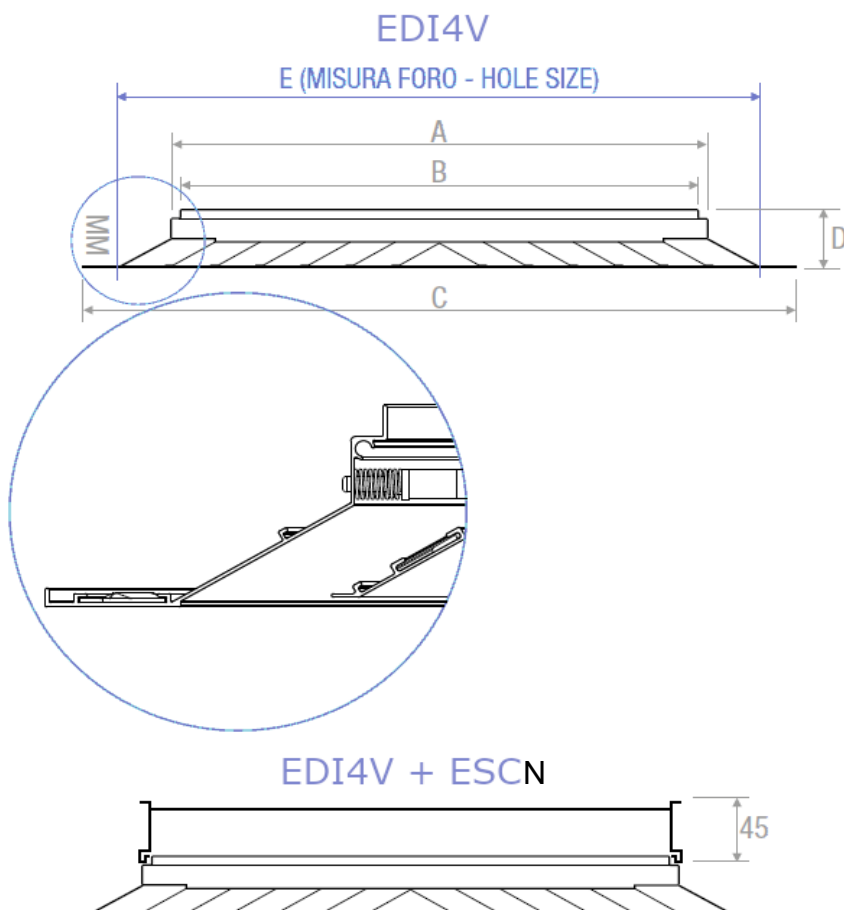

MONTAGGIO E RACCORDO

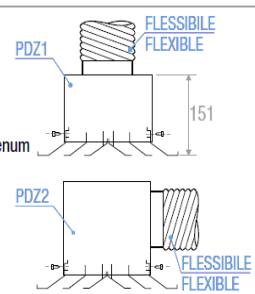
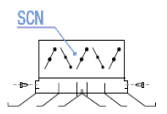
<p>RACCORDO SUL CANALE QUADRATO</p> <p>Inscotolare il diffusore nel canale. Fissare il diffusore con viti.</p> 	<p>RACCORDO SUL CANALE FLESSIBILE CON PLENUM</p> <p>Inscotolare il diffusore nel plenum PDZ1 PDZ2. Fissare il diffusore con viti.</p> 	<p>TARATURA</p> <p>Possibilità di installare una serranda in ogni configurazione. Fissare con clips la serranda sul diffusore.</p> 
---	---	---

DIFFUSORE QUADRATO A 4 VIE

ACCESSORI

Attacchi plenum	
BxH mm	Ø D
150x150	122
225x225	147
300x300	197
375x375	197
450x450	247
600x600	297

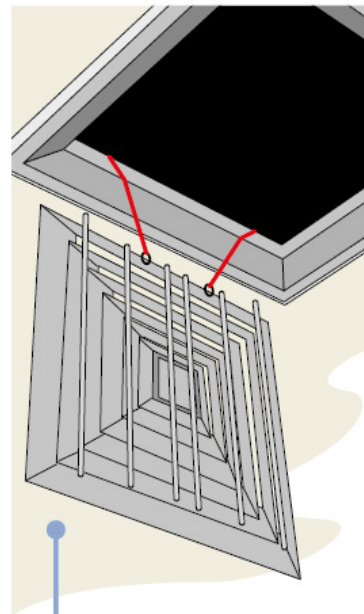

SISTEMA DI SICUREZZA



DIAGRAMMA SCELTA RAPIDA

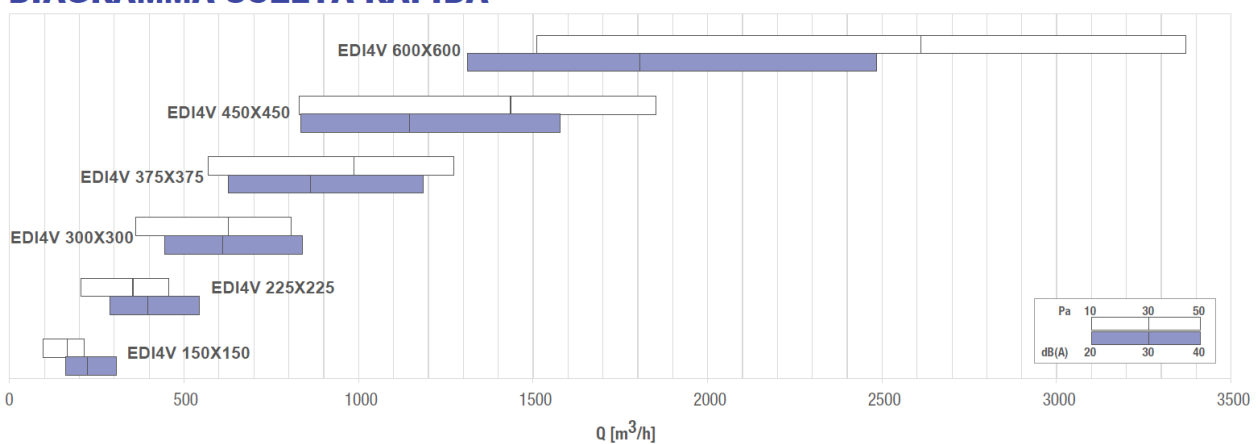

DIMENSIONI

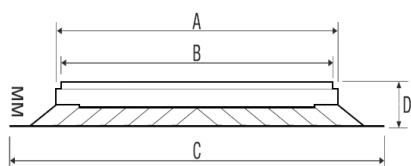

MODELLO	A mm	B mm	C mm	D mm	E mm
150x150	144	128	294	50	240X240
225x225	219	203	369	50	315X315
300x300	294	278	444	50	390X390
375x375	369	353	519	50	465X465
450x450	444	428	594	50	540X540
600X600	597	580	745	50	690X690

Tutte le dimensioni sono espresse in mm.

DATI DI FUNZIONAMENTO EDI4V

BxH mm	Ak [m ²]	No. Vie	Q [m ³ /h]		LWA [dB(A)]		X(0,25) [m]		Dpt [Pa]	
			min	max	min	max	min	max	min	max
150x150	0,0094	4	100	210	< 20	29	0,8	3,99	10	50
225x225	0,0194	4	200	460	< 20	34	0,92	4,61	10	50
300x300	0,0332	4	360	810	< 20	39	1,03	5,14	10	50
375x375	0,0511	4	570	1270	< 20	42	1,12	5,6	10	50
450x450	0,0729	4	830	1850	< 20	45	1,2	6,01	10	50
600x600	0,1284	4	1510	3370	24	50	1,35	6,73	10	50