

Dati di ricerca

Portata[m ³ /h]	1204
Pressione[Pa]	265.1
Tipo di pressione	Psta
Alimentazione	all
Densità[m ³ /h]	1.205

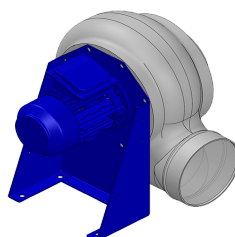

Coclea stampata Pe - girante PP - Supporto motore in lamiera di acciaio verniciato polveri - Viteria acciaio INOX

Etichetta

Codice	P314
Tensione[V]	400
Fasi	3
Corrente nominale[A]	
Poli	4
Peso[kg]	19
Frequenza[Hz]	50
Velocità[rpm]	1400
Potenza[kW]	0.25
IP	55
INS	

Tabella motori

Classe IE	IE1
Taglia	71
Potenza[kW]	0.25
Corrente nominale[A]	0.84
Tensione[V]	400
Cos φ	0.72
n	0.6

Punto di lavoro

Q [m3/h]	1204
Psta [Pa]	265.1
Ptot [Pa]	272.2
Pin [kW] [W]	107.1
nsta	0.828
ntot	0.85
Rpm	1400

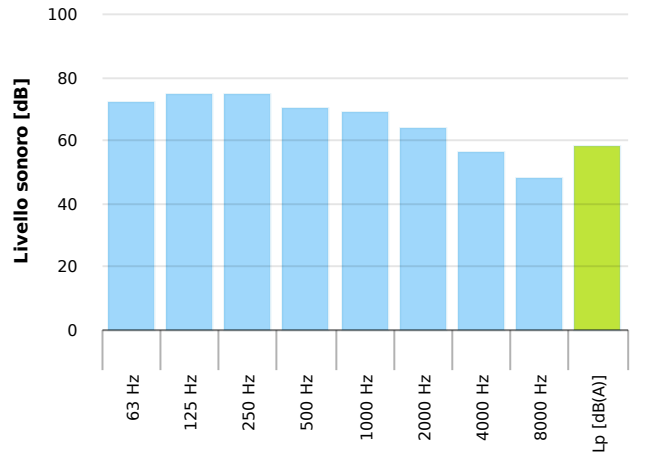
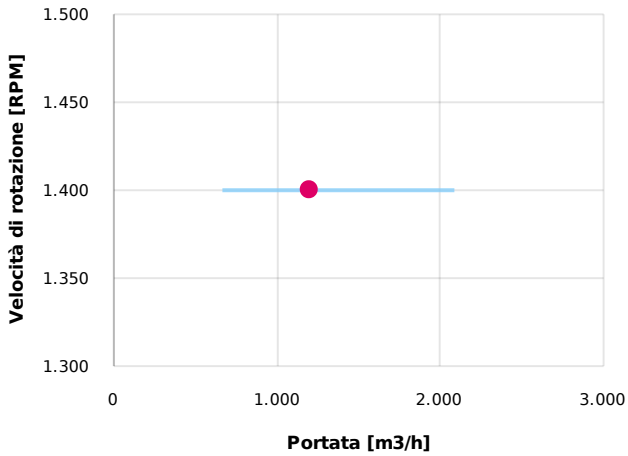
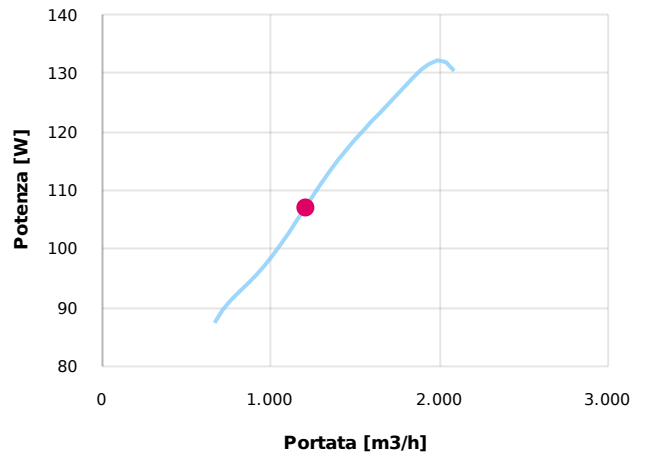
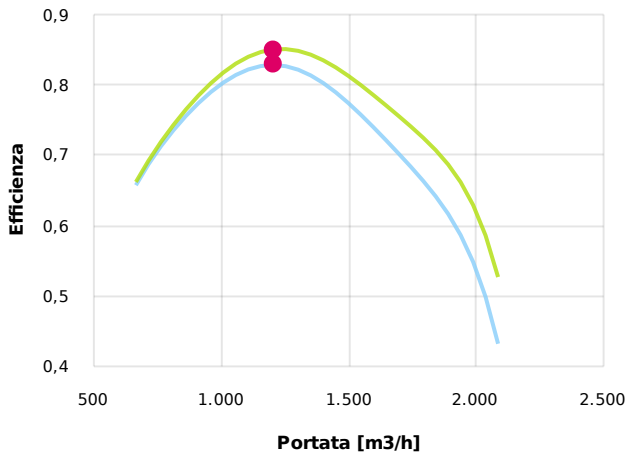
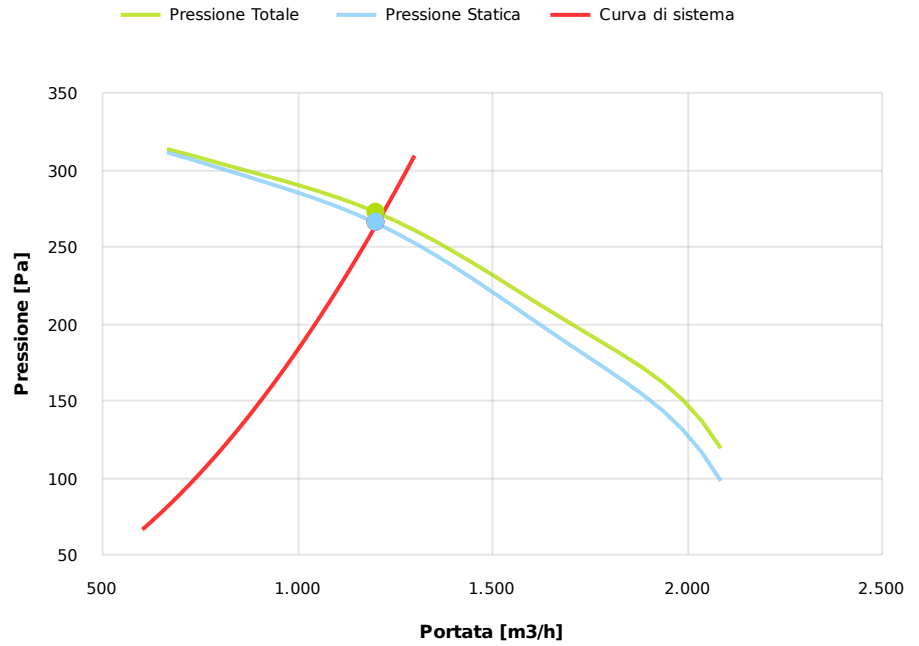

Dimensioni

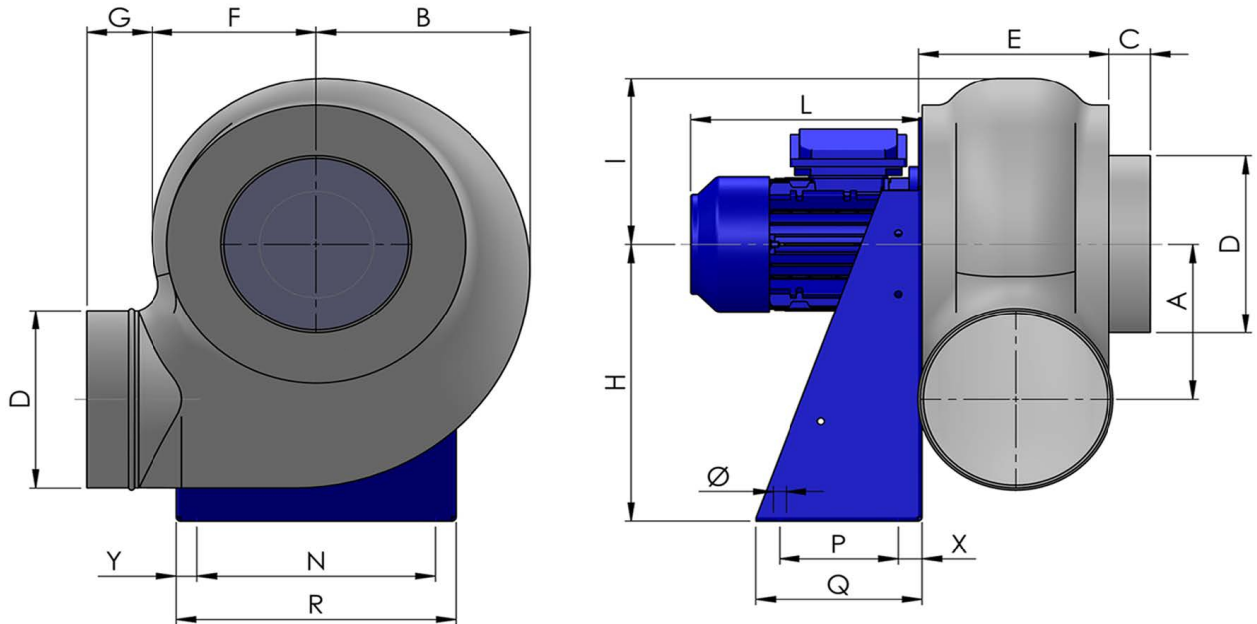

A	B	C	D	E	F	G	H	I	L	N	Ø	P	Q
240	280	40	250	200	210	70	410	230	220	320	11	150	230
R				X				Y					
355				40				175					

Configurazioni & cad

