

Dati di ricerca

Portata[m3/h]	439
Pressione[Pa]	118.6
Tipo di pressione	Psta
Alimentazione	all
Densità[m3/h]	1.205

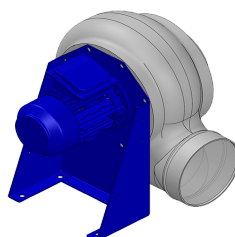

Coclea stampata Pe - girante PP - Supporto motore in lamiera di acciaio verniciato polveri - Viteria acciaio INOX

Etichetta

Codice	P224
Tensione[V]	400
Fasi	3
Corrente nominale[A]	
Poli	4
Peso[kg]	10
Frequenza[Hz]	50
Velocità[rpm]	1370
Potenza[kW]	0.12
IP	55
INS	

Tabella motori

Classe IE	IE1
Taglia	63
Potenza[kW]	0.12
Corrente nominale[A]	0.47
Tensione[V]	400
Cos φ	0.64
n	0.57

Punto di lavoro

Q [m3/h]	439
Psta [Pa]	118.6
Ptot [Pa]	120.9
Pin [kW] [W]	17.11
nsta	0.847
ntot	0.863
Rpm	1370

— Pressione Totale — Pressione Statica — Curva di sistema

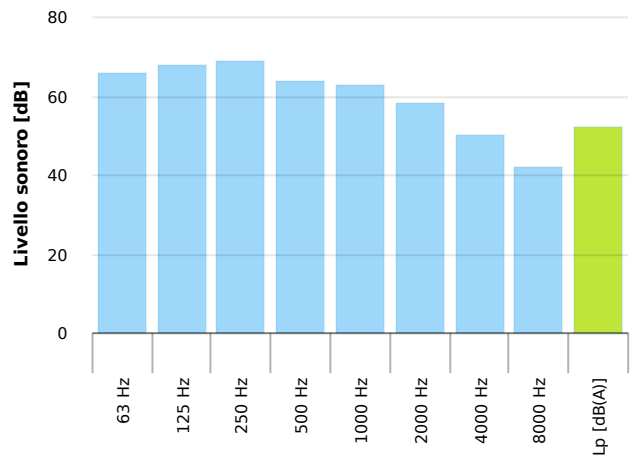
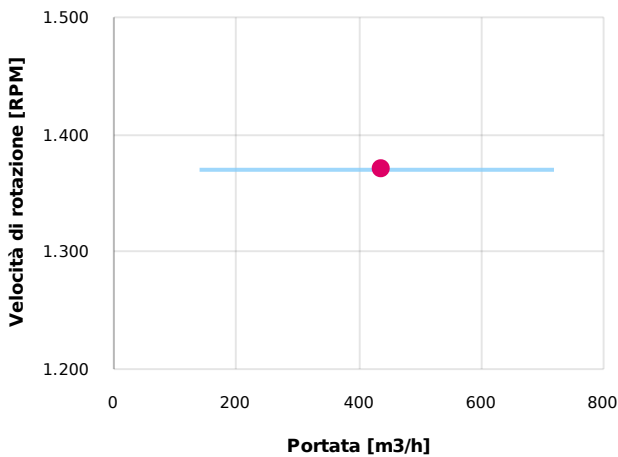
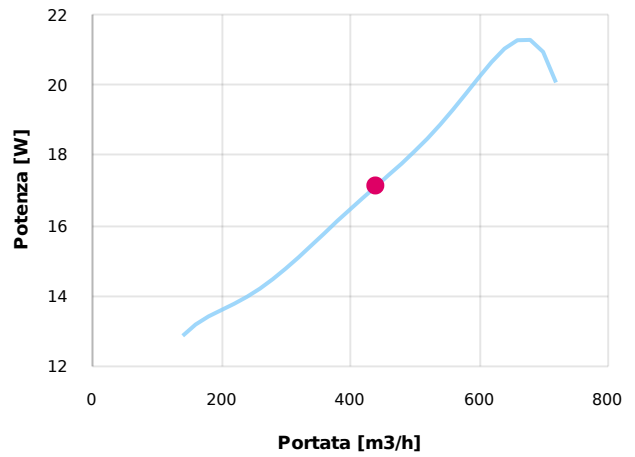
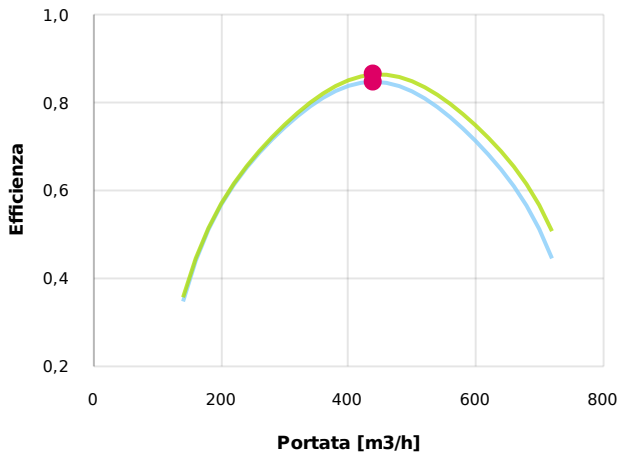
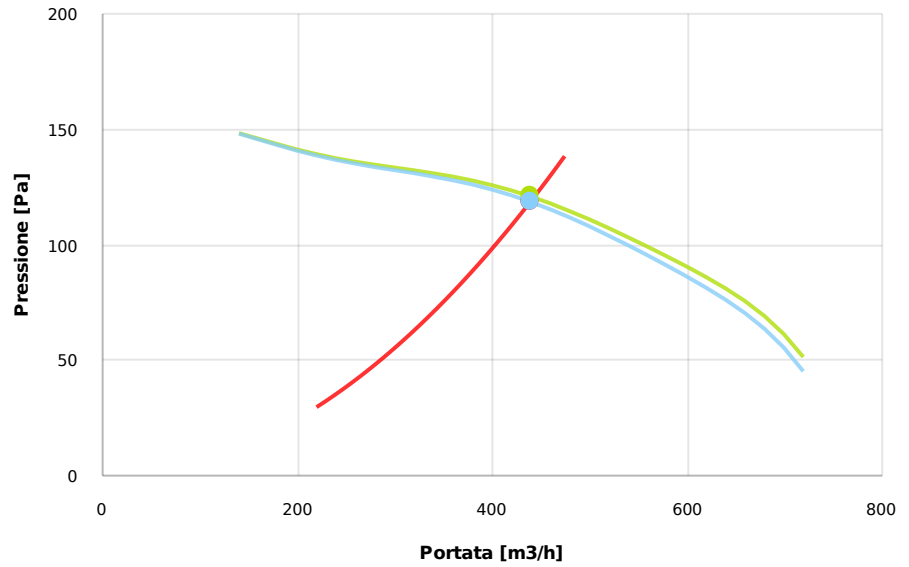

Dimensioni

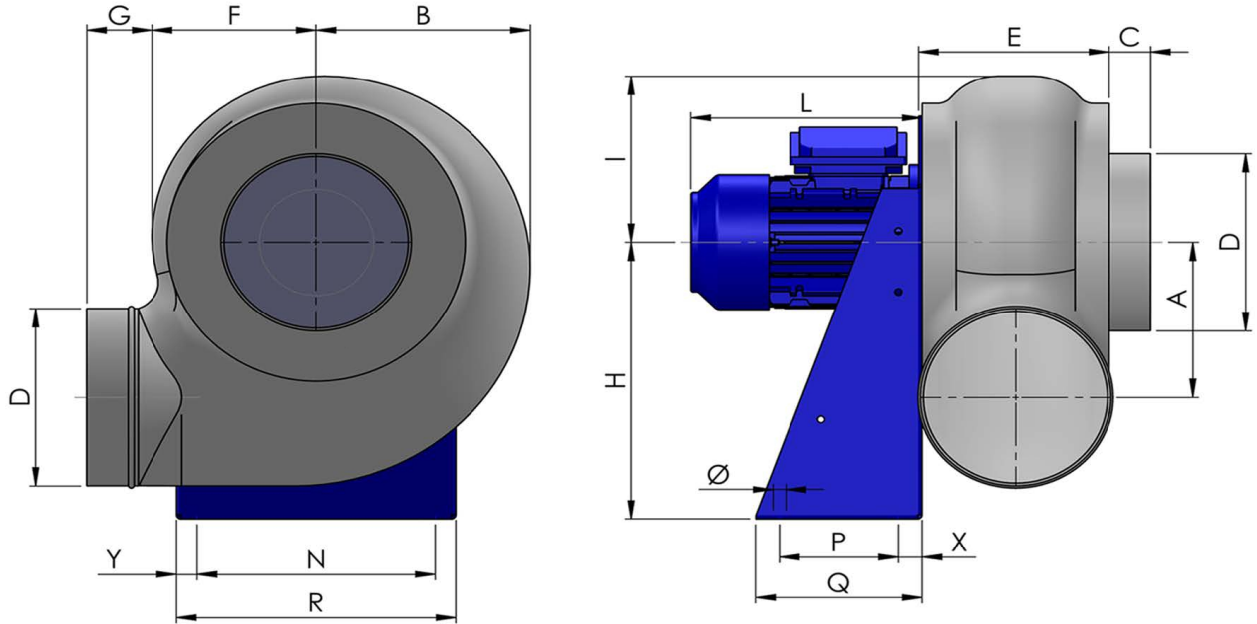

A	B	C	D	E	F	G	H	I	L	N	Ø	P	Q
173	228	35	200	185	170	55	310	190	190	255	11	100	140
			R				X					Y	
			290				20					175	

Configurazioni & cad

