

SERRANDA DI TARATURA



DESCRIZIONE

Le serrande di regolazione leggera a farfalla serie ESR sono costruite in lamiera zincata, tagliata e saldata al laser e complete di comando manuale autobloccante per la regolazione dell'apertura. A richiesta è possibile trasformarle in motorizzate con l'ausilio di un accessorio composto da un perno ed una piastra. Il campo di lavoro in temperatura è da -15°C a +100°C. La serie ESR è disponibile fino al diametro DN 500mm.

DIAMETRI DI PRODUZIONE

80	100	125	150	160	200	250	300
315	355	400	450	500	560	630	

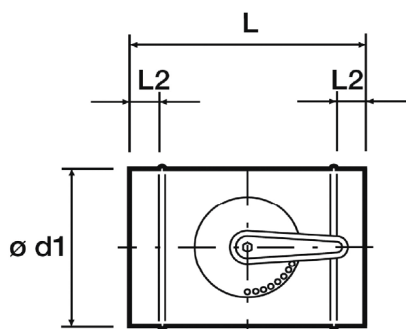

DIMENSIONI ESR

Modello ESR (mm)	Dimensioni		Modello ESR (mm)	Dimensioni	
	L	L2		L	L2
80	200	40	250	250	40
100	200	40	280	280	60
125	200	40	300	300	60
140	200	40	315	315	60
150	200	40	355	355	60
160	200	40	400	400	80
180	200	40	450	450	80
200	200	40	500	500	80

DIAGRAMMA DI PORTATA



DIAGRAMMA DI PORTATA



N.B: I valori indicati possono essere soggetti a modifiche senza preavviso

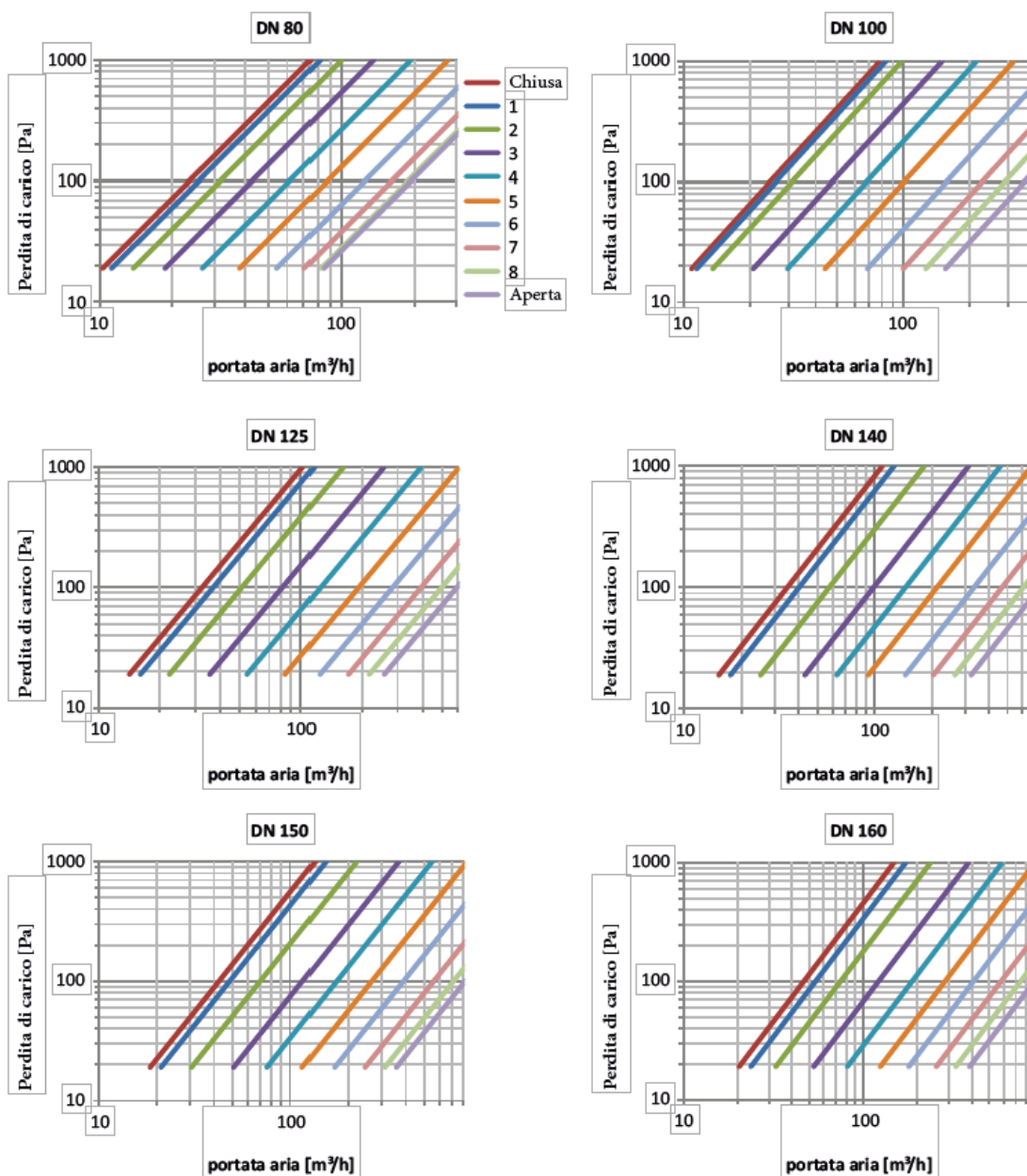
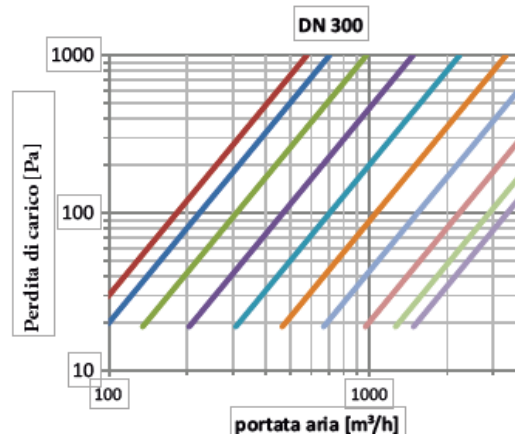
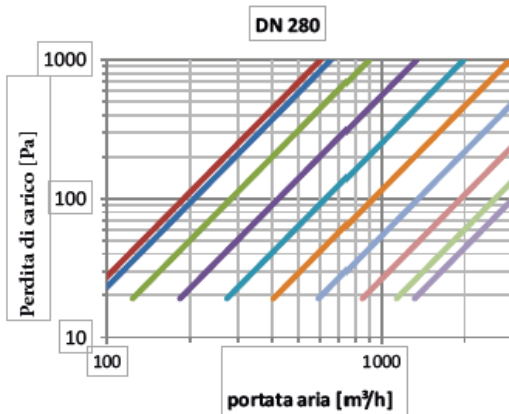
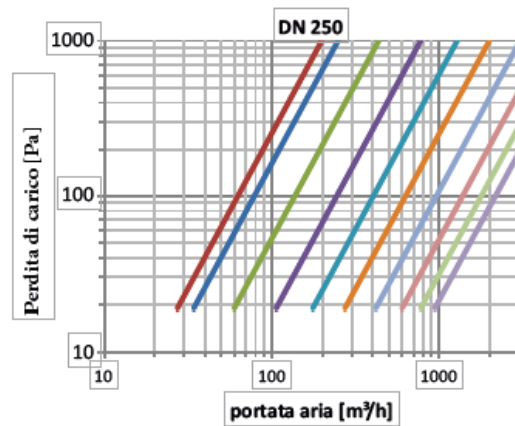
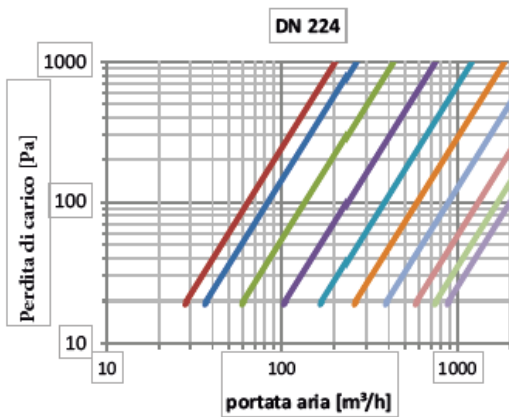
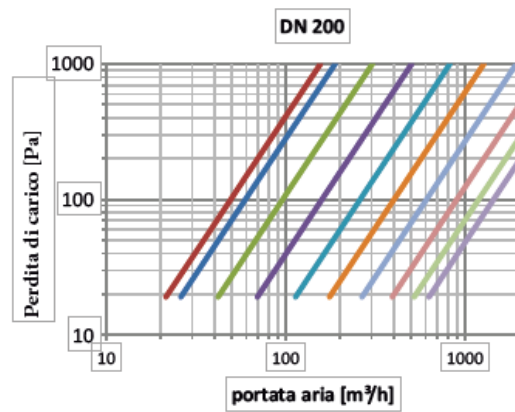
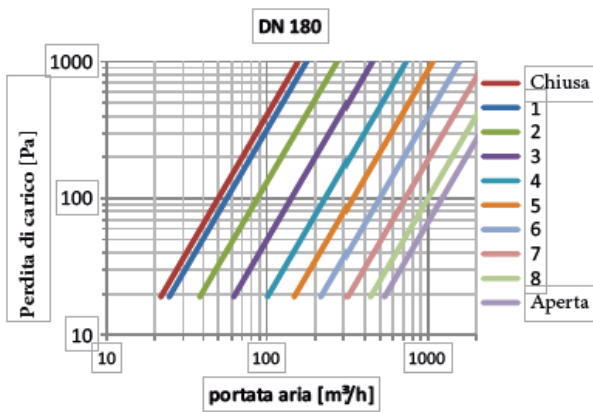

DIAGRAMMA DI PORTATA

